

Volume of Pyramids

Name: _____

Accelerated 7th Grade Math

Find the VOLUME of the following pyramids

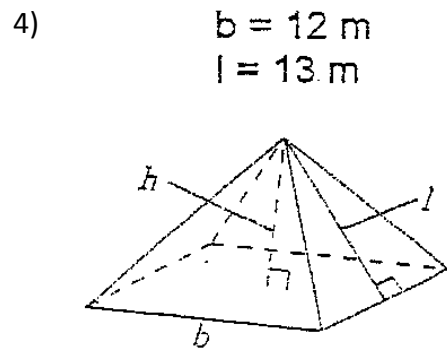
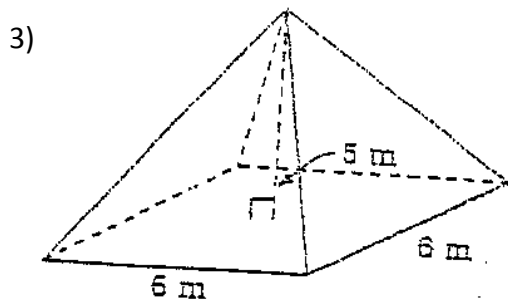
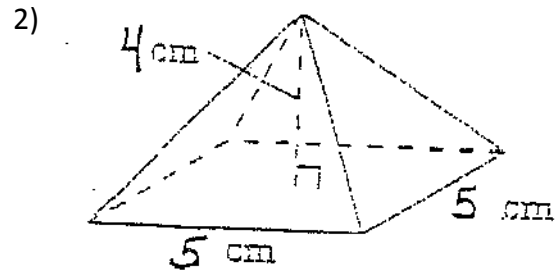
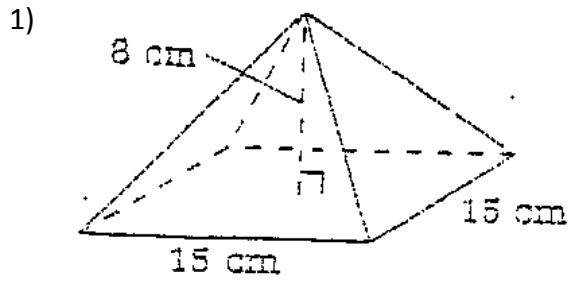

5)

$$h = 11 \text{ cm}$$
$$l = 61 \text{ cm}$$

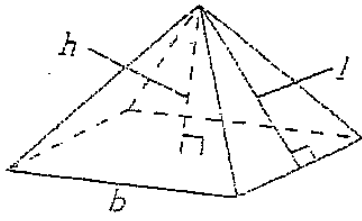

6)

$$b = 42 \text{ inches}$$
$$h = 28 \text{ inches}$$

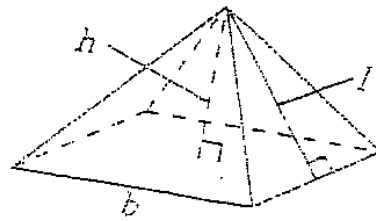

7)

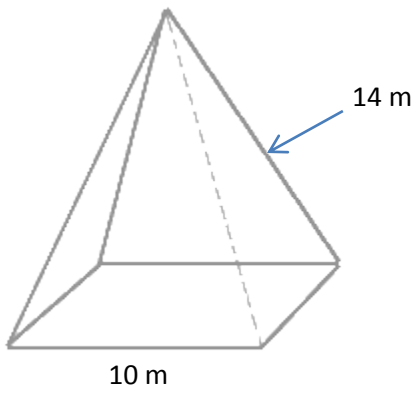

8)

