

Triangle Rules

NAME _____

Triangle Inequality Theorem

The sum of any two sides of a triangle must be greater than the third side.

Can the three sides form a triangle? Explain why or why not.

1.

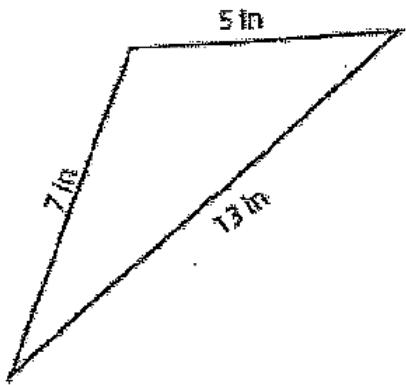

2.

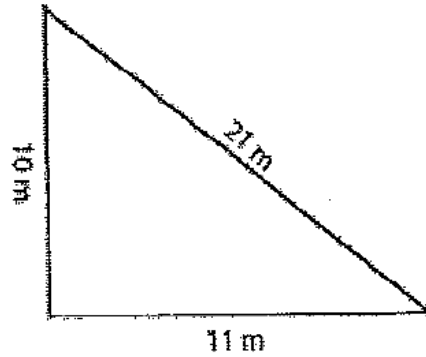

3.

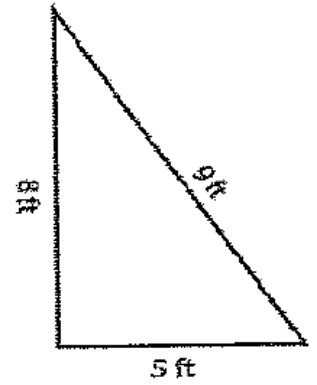

4.

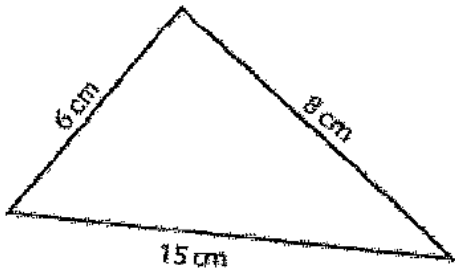

5.

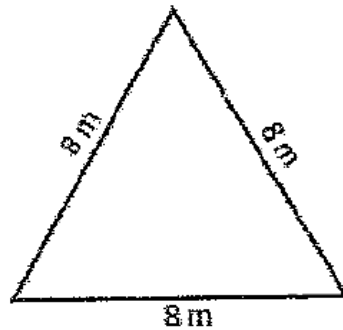

6.

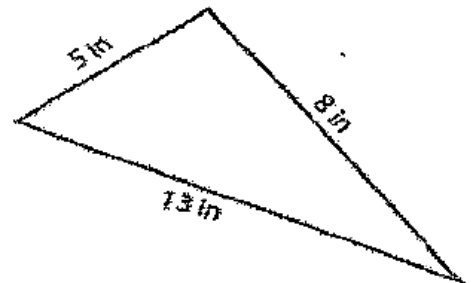

7. 3, 4, 9

8. 8, 7, 2

9. 14, 3, 9

10. 4, 9, 5

Triangle Sum Theorem

The sum of the angles of a triangle must add up to 180° .

Find the missing angle in each triangle.

11.

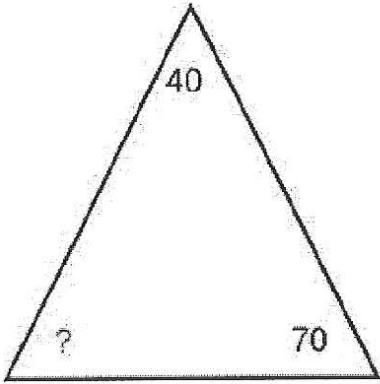

12.

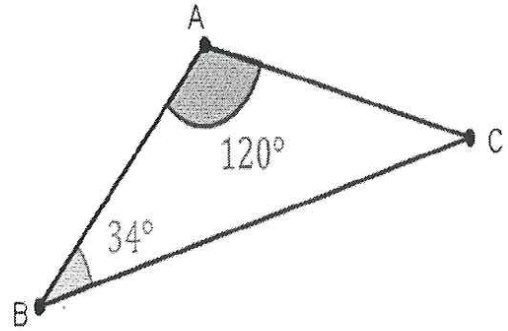

13.

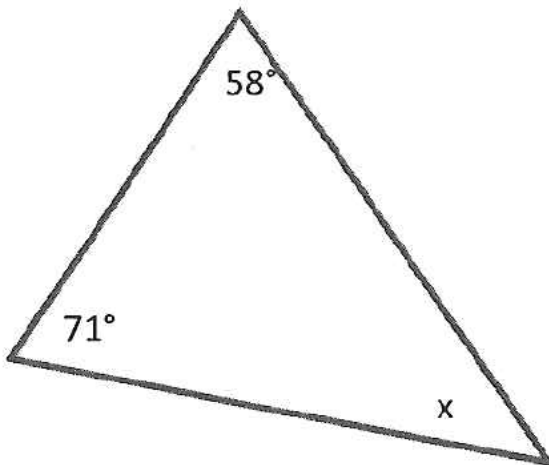

14.

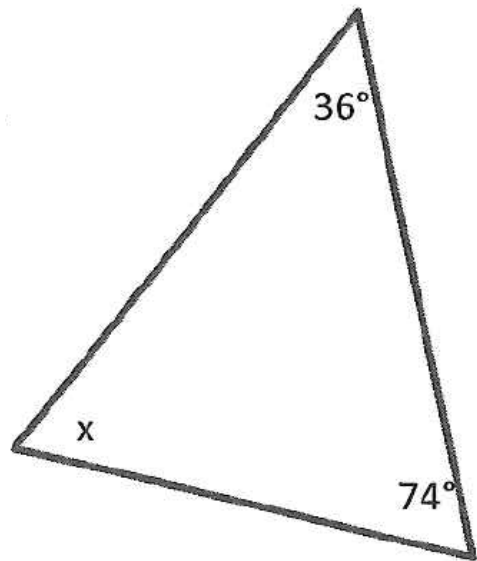

15.

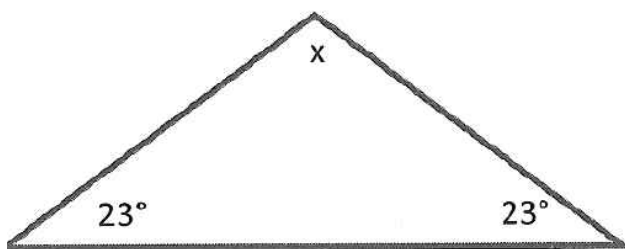

16.

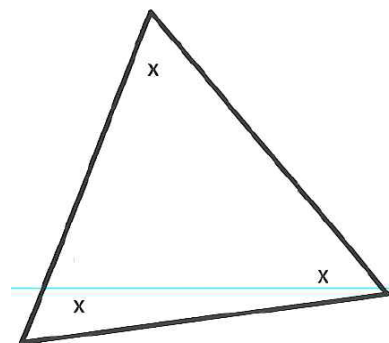

17. For each of the following, write an equation and find each of the angles...

Find all the angles in each of the following...

1.

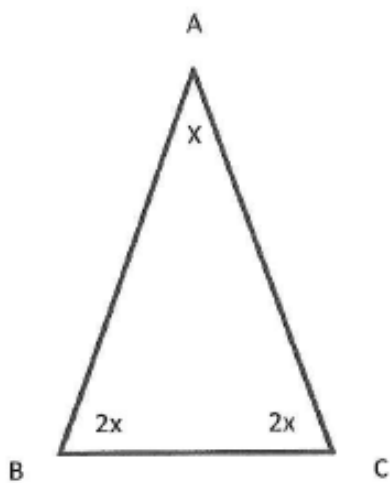

$\angle A = \underline{\hspace{2cm}}$

$\angle B = \underline{\hspace{2cm}}$

$\angle C = \underline{\hspace{2cm}}$

2.

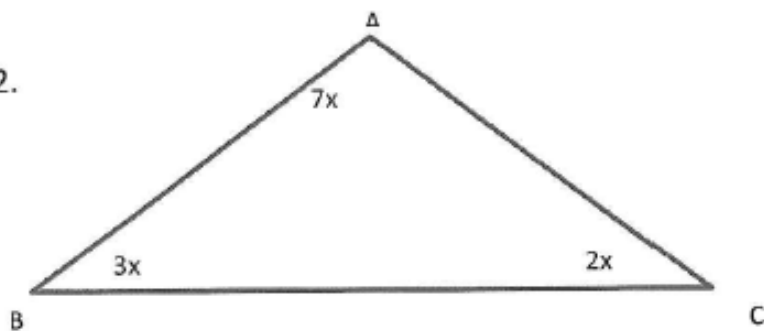

$\angle A = \underline{\hspace{2cm}}$

$\angle B = \underline{\hspace{2cm}}$

$\angle C = \underline{\hspace{2cm}}$

3.

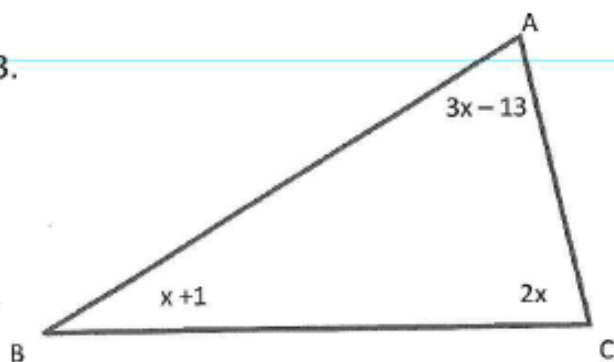

$\angle A = \underline{\hspace{2cm}}$

$\angle B = \underline{\hspace{2cm}}$

$\angle C = \underline{\hspace{2cm}}$