

Area Test Review

Name _____

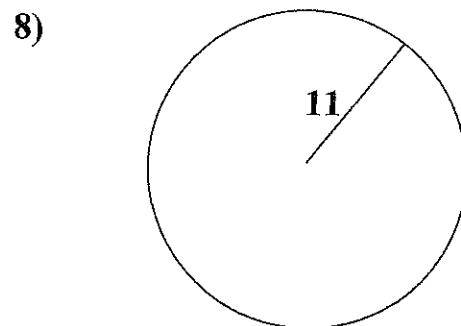
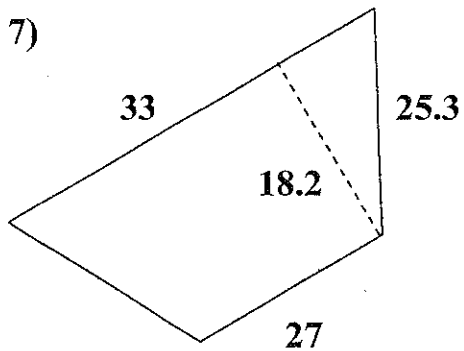
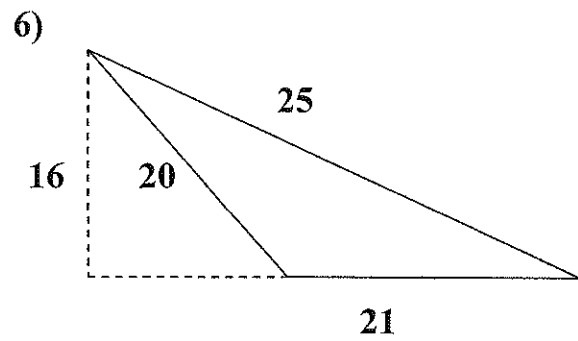
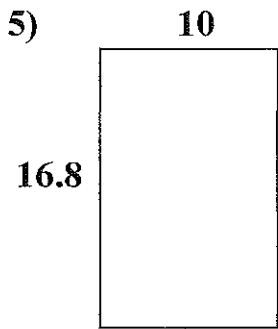
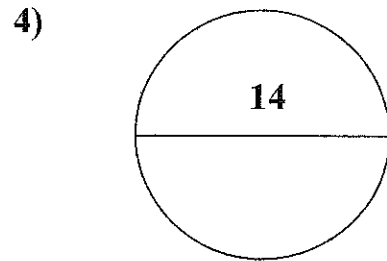
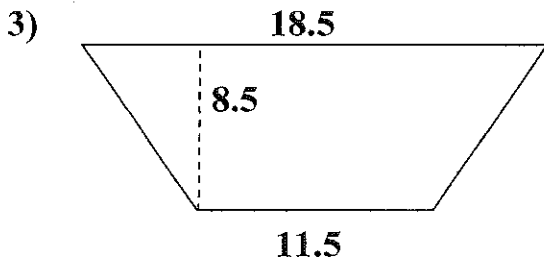
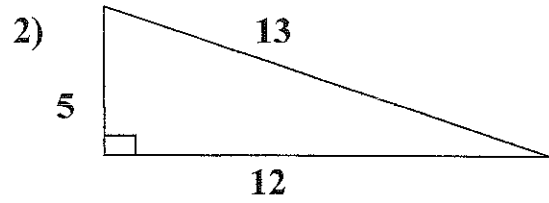
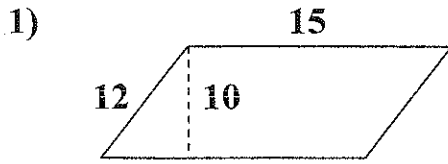

Find the area of the shaded region.

9)

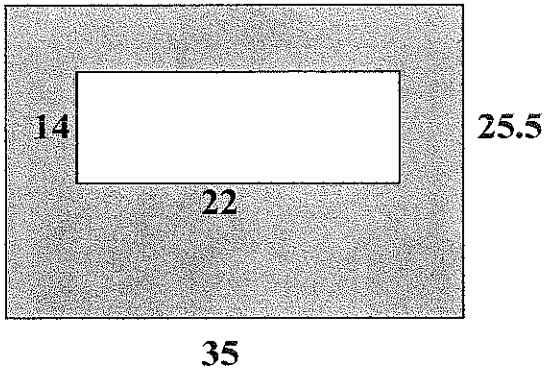

10)

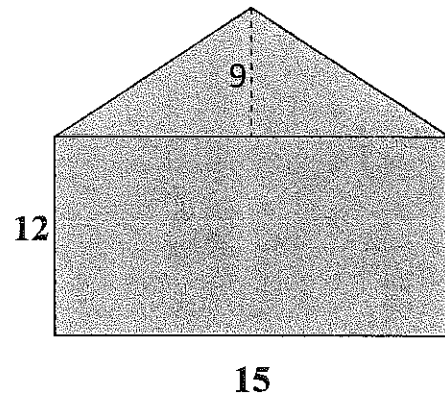

11)

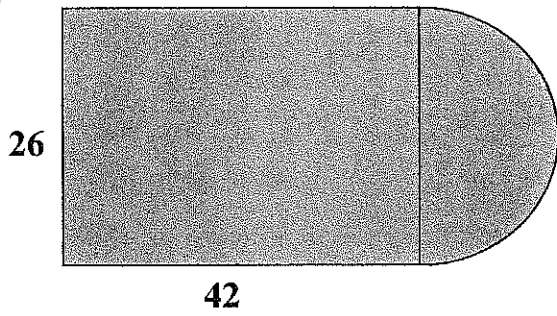

12)

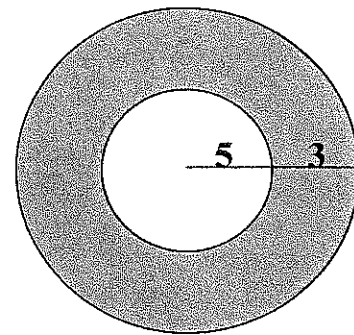

Plot the points, connect them, and find the area of the figure.

13) A(-4, 6) B(-1, -1) C(3, -1) D(6, 6)

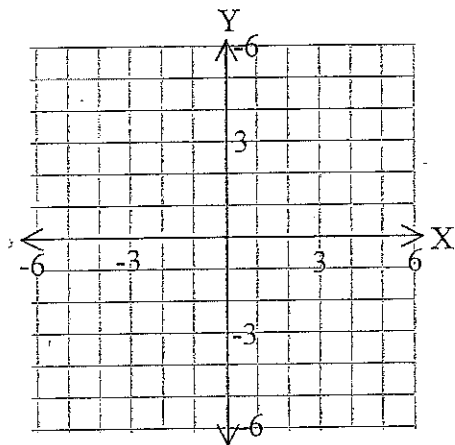

14) A(2, 5) B(4, -3) C(-3, -3)

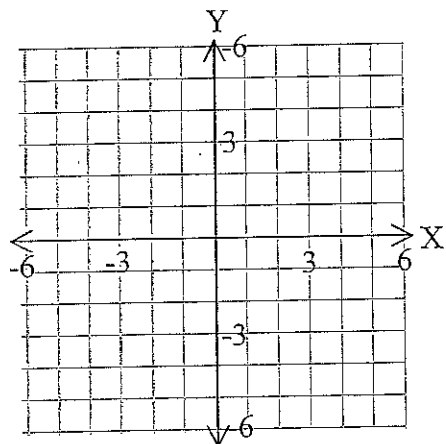

15) A(-2, 6) B(0, 6) C(5, -4) D(3, -4)

