

Surface Area of Pyramids

Name: _____

Pre-Algebra

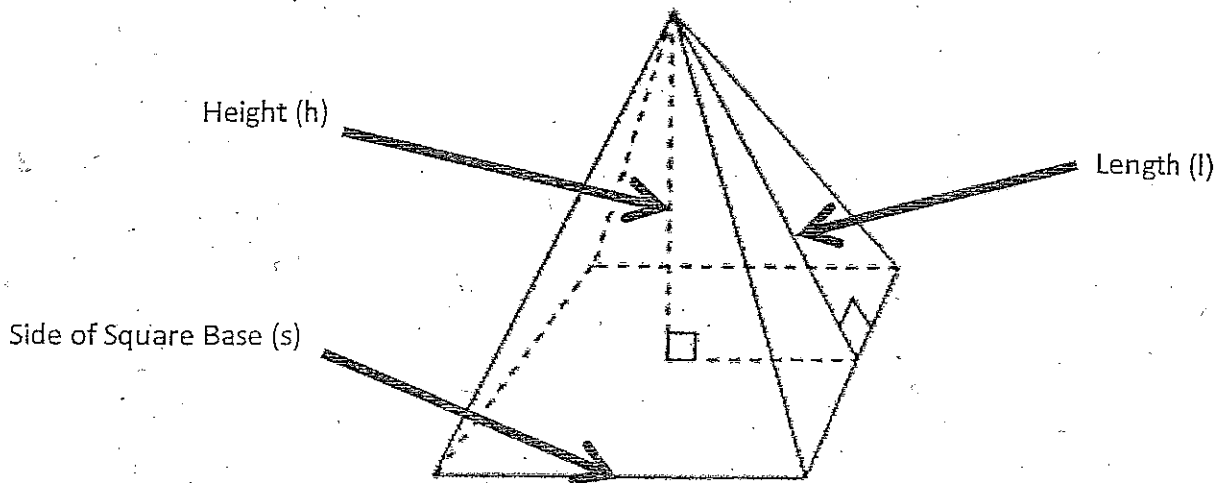

Find the surface area of the following pyramids.

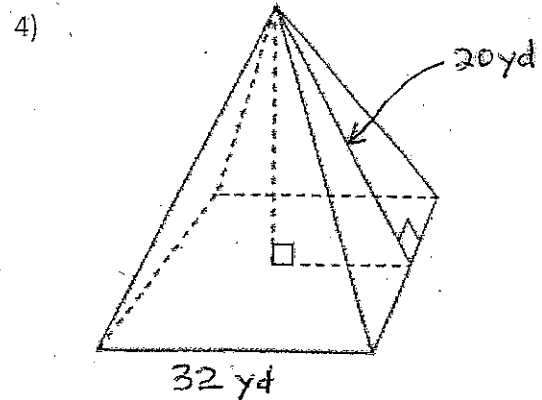
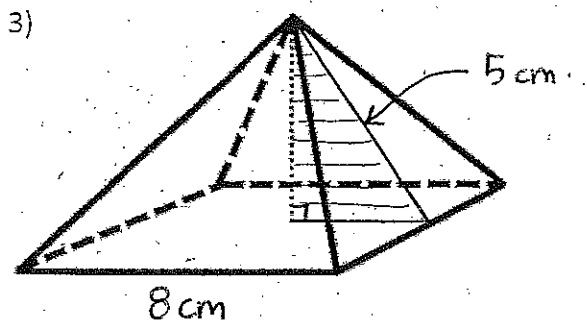
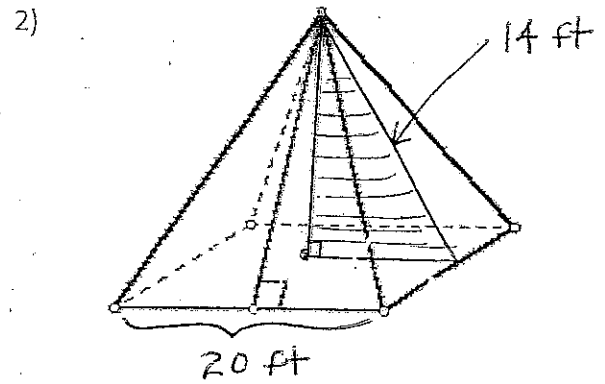
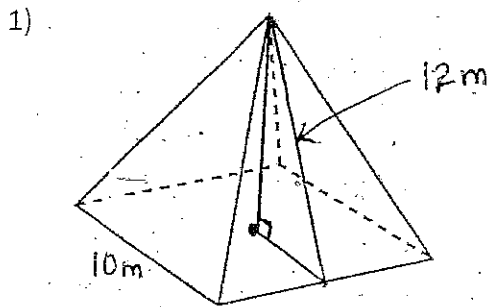

5)

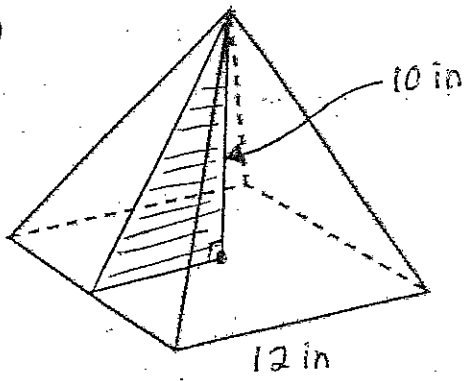

6)

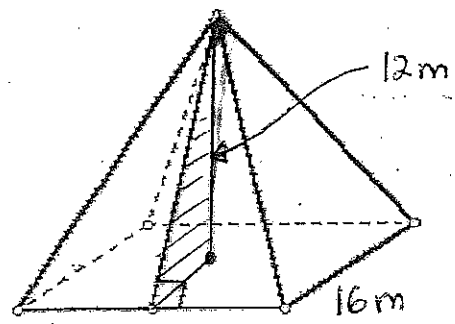

7)

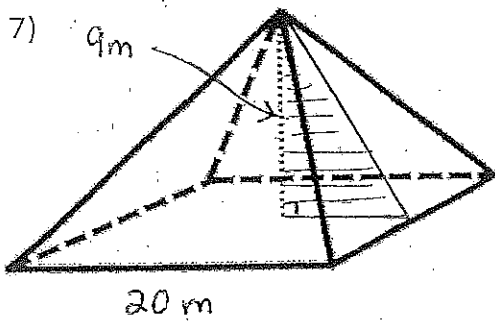

8)

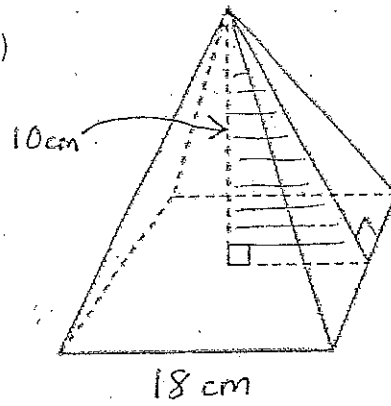

9)

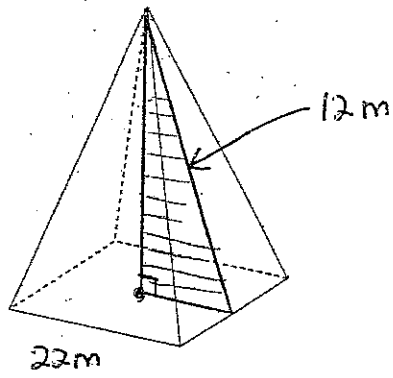

10)

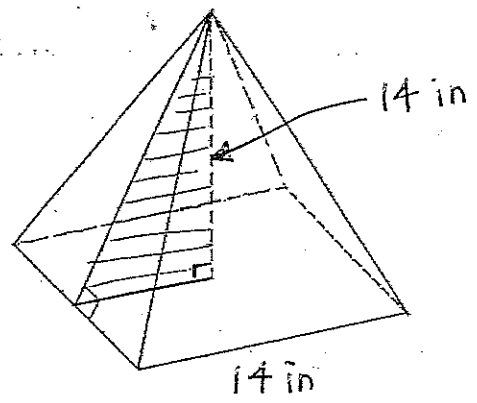

11)

